

# REM

## Fiber Solutions

Multi-Signal transport to meet new requirements

### Here is a brief summary of our main products

Visit Our website to see our more recent devices

Contact us, we could find the more efficient solution for your business

*Click on tag to visit the device page on our website*

**REM** VIA A.Bisi, 26  
20152 Milan (MI) ITALY  
[info@remsnr.it](mailto:info@remsnr.it) [www.remsnr.it](http://www.remsnr.it)  
+39-348.314.77.83 (H24 number)

### Quick Products Summary

**VIDEO**

**AUDIO**

**DATA**

**POWER**

**Single Fiber** plus Redundancy

**Fiber Pair**

**Hybrid (SMPTE)**

**Hybrid**

**FlexyBUS**

*A smart Idea*

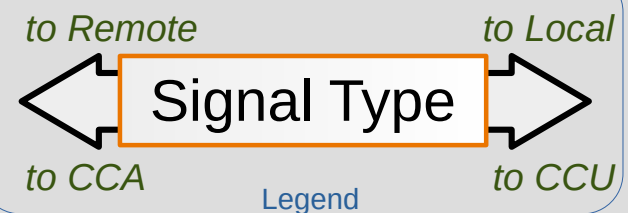

# VIDEO

3G-SDI

3G-SDI

3G-SDI

3G-SDI

# DATA

Ethernet / FlexyBus

RS422

Tallies / GPIs

# POWER

DC (Hybrid Opt.)



Fiber Pair

or

Hybrid



Fiber Redundancy !!!

# AUDIO

Microphone 1

Microphone 2

Microphone 3

Talk Back A/B/C

Program 1 / 2

Return A/B/C

Tie-Line 1 or Mic 4

Tie-Line 2 / 3

Audio Utility (+BT)

Intra Comm.

User Line / GPI

WEB PAGE CTRL

**3 Commentary  
ComMEDIA**

# VIDEO

3G-SDI

3G-SDI

3G-SDI

3G-SDI

# DATA

Ethernet / FlexyBus

RS422

Tallies / GPIs

# POWER

DC (Hybrid Opt.)



Fiber Pair

or

Hybrid



Fiber Redundancy !!!

# AUDIO

Microphone 1

Microphone 2

Talk Back A/B

Program 1 / 2

Return A/B

Tie-Line 1 or Mic 3

Tie-Line 2

Audio Utility (+BT)

Intra Comm.

WEB PAGE CTRL

**2 Commentary  
ComMEDIA**

## VIDEO

3G-SDI

3G-SDI

3G-SDI (Option)

## DATA

RS422

Tallies / GPIs

Similar Audio Features  
of Dual Commentary  
Less Video and Data  
Fiber Pair Connection  
*Useful for Fly-Case and  
Small OB-Van*

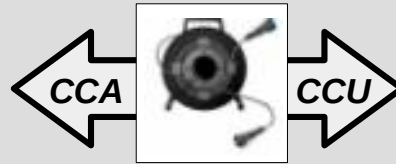

Fiber Pair



**Commentary  
ComMEDIA  
Lite**

## AUDIO

Microphone 1

Microphone 2

Talk Back A/B

Program 1 / 2

Return A/B

Tie-Line 1 or Mic 3

Tie-Line 2

Audio Utility (+BT)

Intra Comm.

WEB PAGE CTRL (opt)

## VIDEO

3G-SDI 1 (12G opt)

3G-SDI 2 (12G opt)

## DATA

Remote 1 (RS422)

Remote 2 (RS232)

Remote 3 (LANC)

Ethernet 1G (opt.)

## System Options

Intercom  
Base Station Opt.

Hybrid Connector  
Lemo or Neutrik



Fiber Pair

or

Hybrid



CCA camera Adapter

Camera Link  
**MIDI**

## AUDIO

Intercom

Aux Audio (opt.)

## Timing - Aux

Genlock

Timecode

Tallies / GPI

## POWER

DC (Hybrid Opt.)

Multi-Brand Cameras Hybrid System

Up to **FOUR** cameras 1RU



Hybrid Option Frame

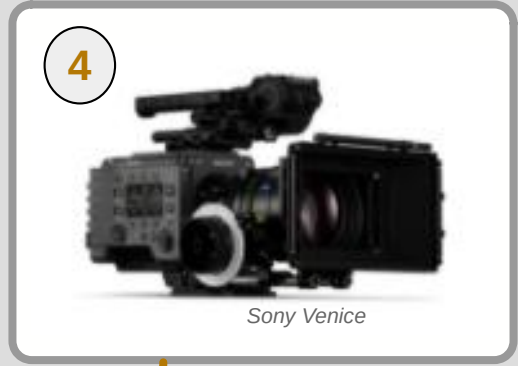

Sony Venice

Transform your Camcorder into a Full Featured Studio Camera

Fiber Pair or Hybrid Rugged Cables

CCA Camera Adapter



CCU Cambox Control Unit with IBS



Perfect for Fly-Case or OB-Van



Multi-Brand Cameras Hybrid System Up to **FOUR** cameras 1RU

Hybrid Option Frame



Single Channel Wall-Box

# Camera Link MIDI

## VIDEO

12G-SDI 1

2

3G-SDI 2

3G-SDI 3

3G-SDI 4

## DATA

Remote 1 (RS422)

Ethernet 1G

**Scala is modular !!**

Select your required  
configuration



Hybrid



**PTZ Link  
Scala**

## AUDIO

Mic+ /Tieline

Tieline

## Timing - Aux

Genlock

Timecode

Tally / GPI

## POWER

DC (12 or 24 Vdc)

**PTZ High End Hybrid Link  
Single or Dual CCU**

Perfect for  
**Panasonic AW-UE150  
Canon CR-N500**



# VIDEO

3G-SDI

2

3G-SDI (Option)

12G-SDI (Option)

# DATA

Ethernet 1G

RS422

CCA



CCU

# Timing - Aux

Genlock

Timecode

Audio

Tally

# POWER

DC Out 80W

Fiber Pair

Opt..

PTZ Adapter  
Senko  
show



Classic SMPTE Link

Neutrik or Lemo (SMPTE)

PTZ Link  
Scala Lite



Panasonic  
Canon  
Sony  
....



# VIDEO

3G-SDI

3G-SDI (Option)

12G-SDI (Option)

# DATA

Ethernet 1G

RS422

# Timing - Aux

Genlock

Timecode

Audio

Tally

# POWER

DC (30W)



Fiber Pairs



Hybrid



Sony  
Canon  
Panasonic

PTZ Adapter  
Senko  
show



Studio - Theatre  
Indoor Solution

**PTZ Link  
Scala ST**  
Studio & Theatre

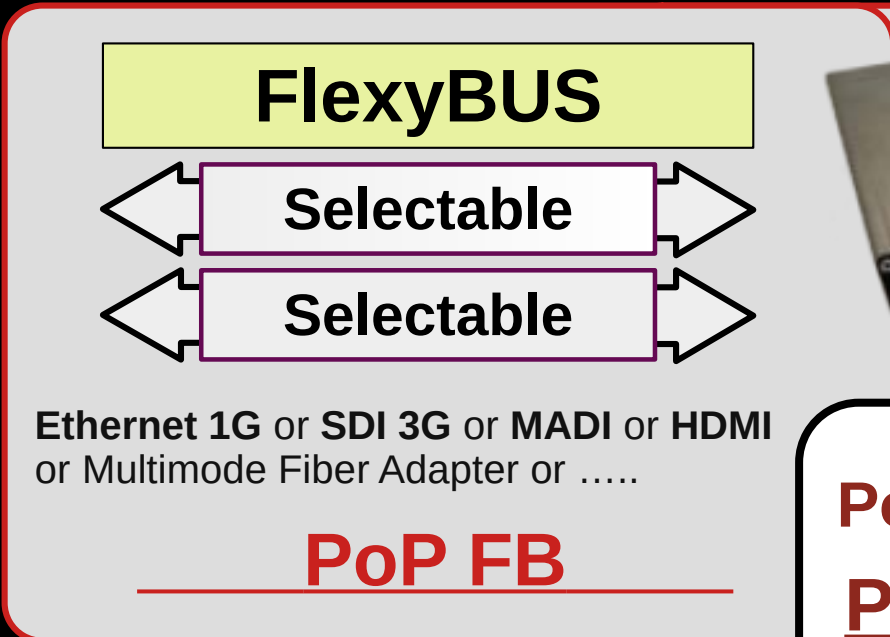
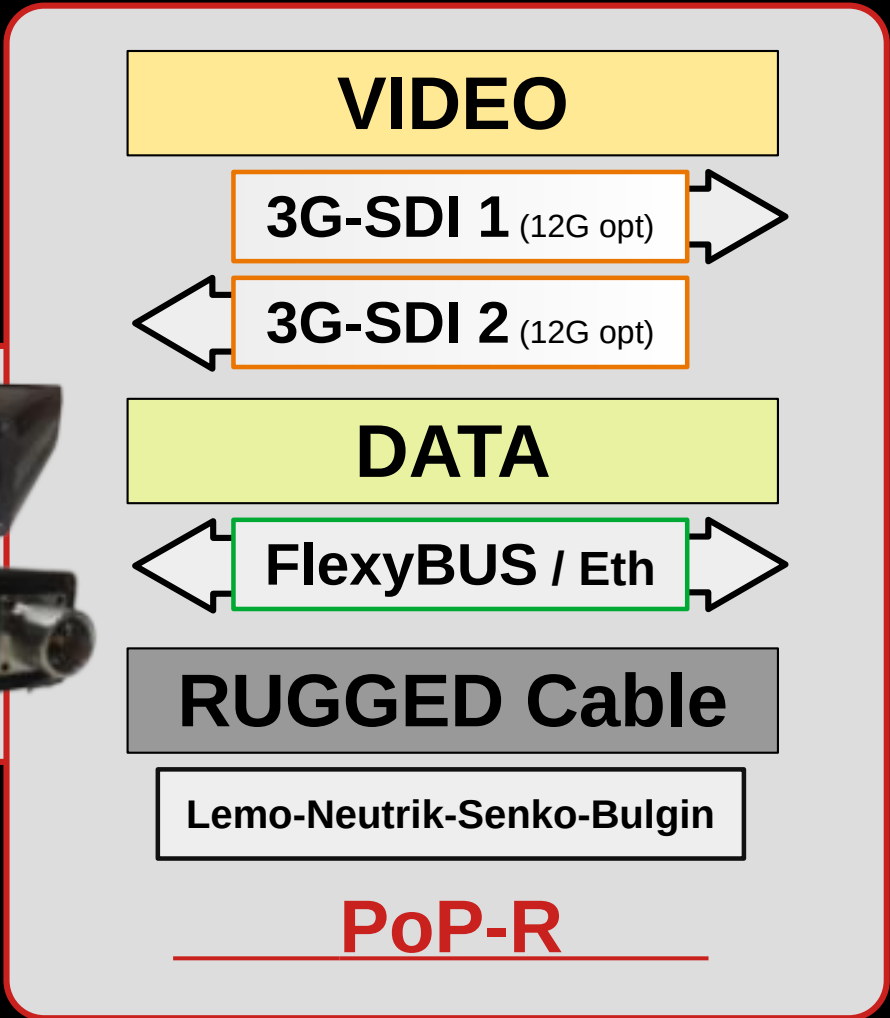
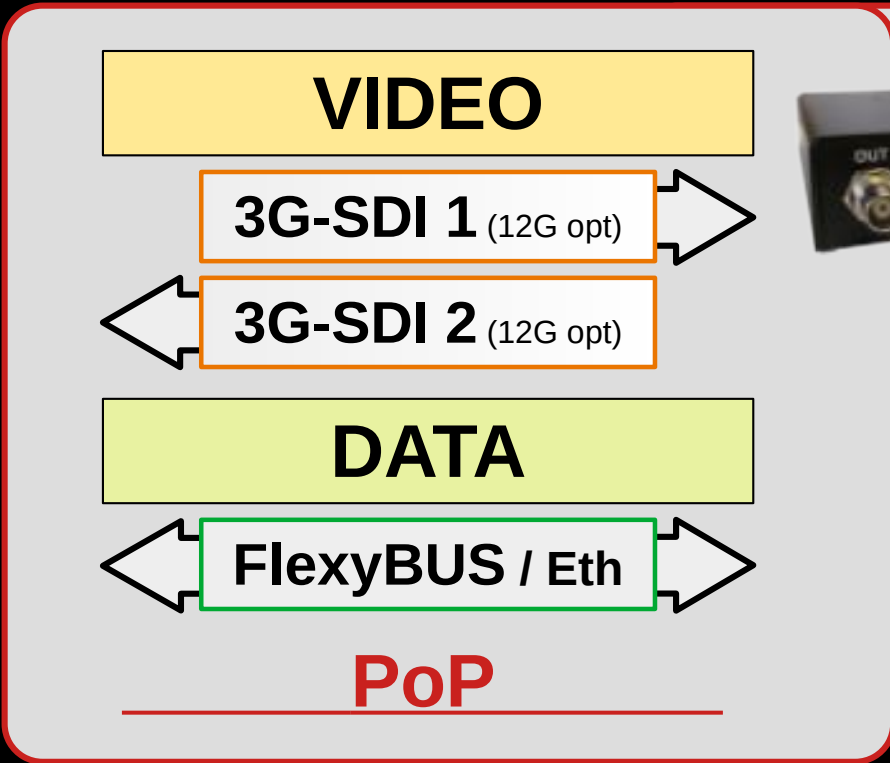

**Point to Point PoP Family**

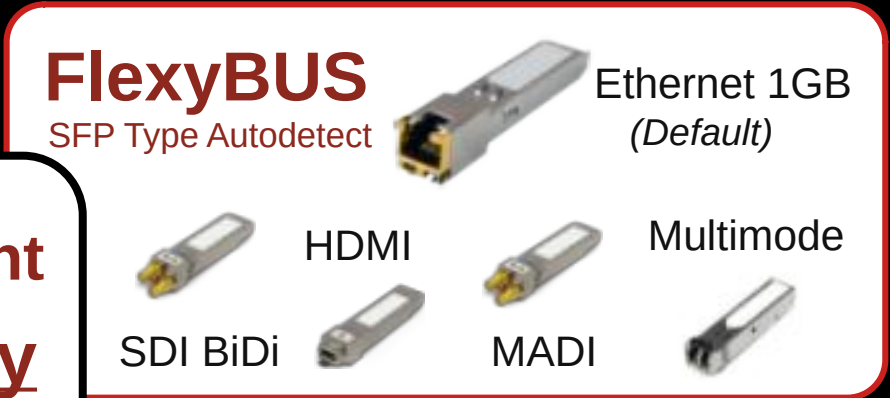

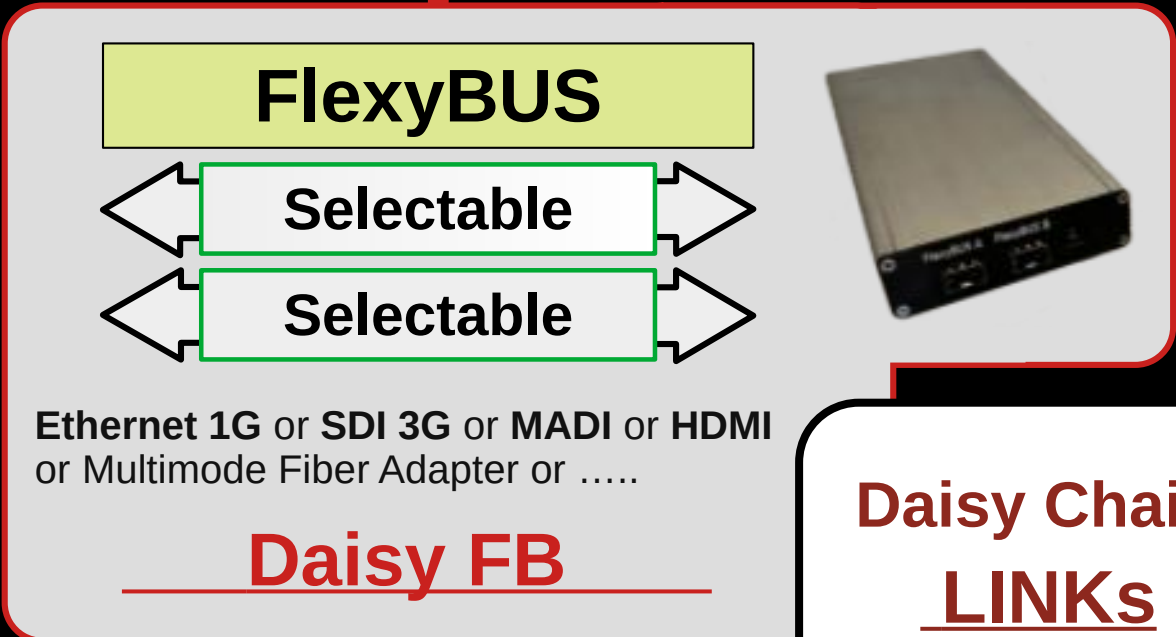
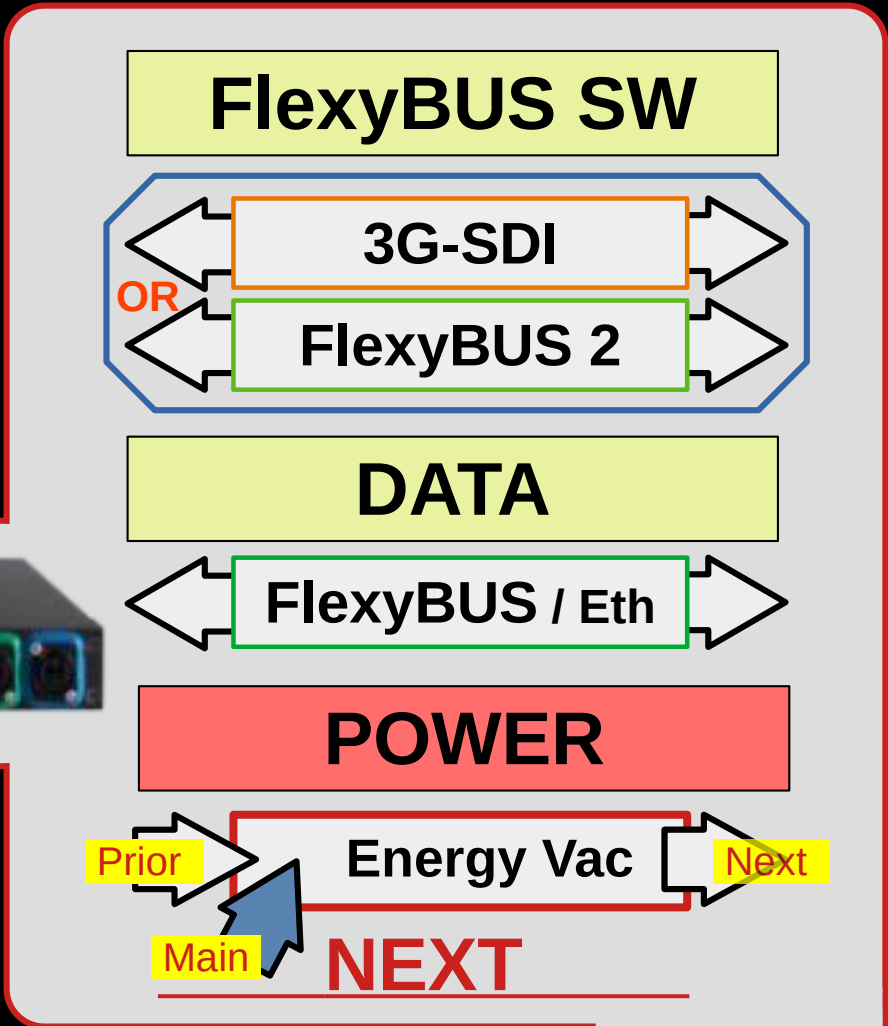
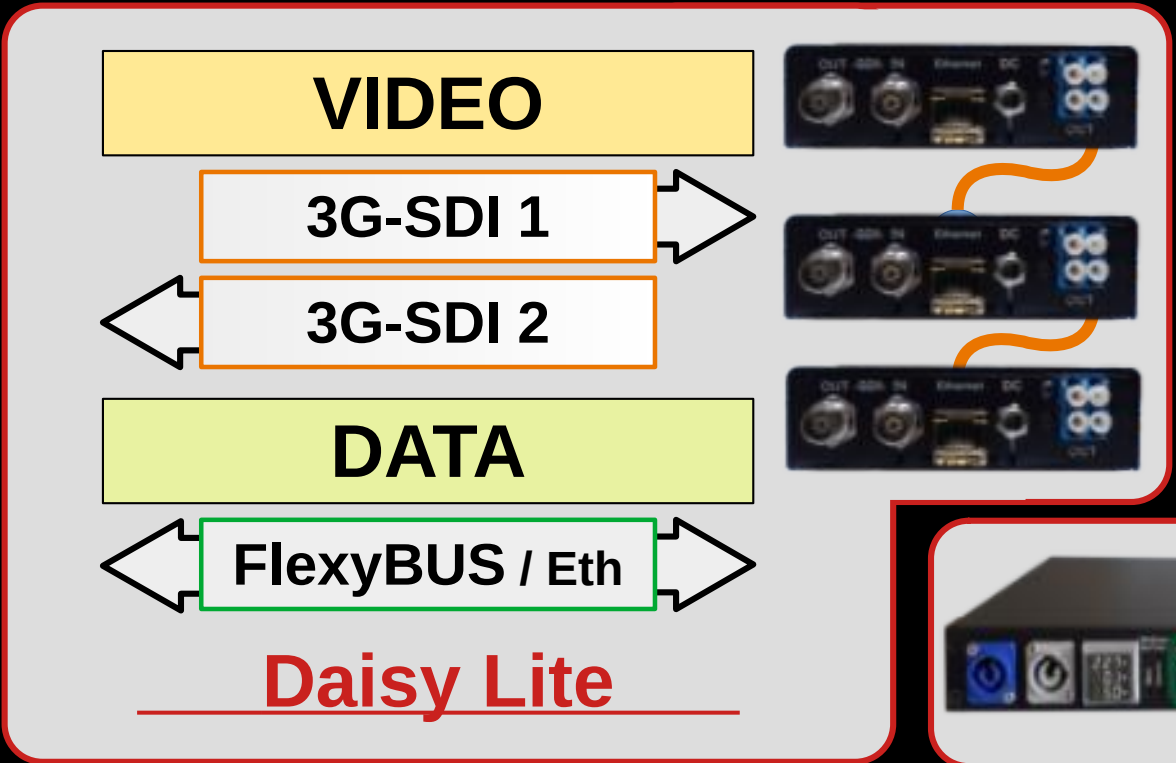

**Daisy Chain LINKs**



## PoP

Point to Point Fiber Pair LC/LC

## Daisy FB

Cascade Fiber Pair LC/LC

## Daisy Lite

Cascade Fiber Pair LC/LC

## Daisy

Cascade Fiber Pair Rugged ½ RU

## Next

Cascade Fiber Pair Hybrid ½ RU

### Local – Remote Chain Concept

Units can be chained in any order.

The signals are units label related:

Local A ↔ Remote A,

Local E ↔ Remote E,

Local C ↔ Remote C and so on

Branches are free, for example

Branch 1 = A, E, C

Branch 2 = D, F

Branch 3 = B alone

Branch 4 = H, G

Max 8 units per branch (A-H)

Max Total Length: 5 Km

Max Current in Hybrid: 2,5 Amp



Hybrid  
(SMPTE)

Fiber  
(Rugged)



Fiber  
(LC/LC)

## Daisy Chain LINKs

### CAMBOX Daisy

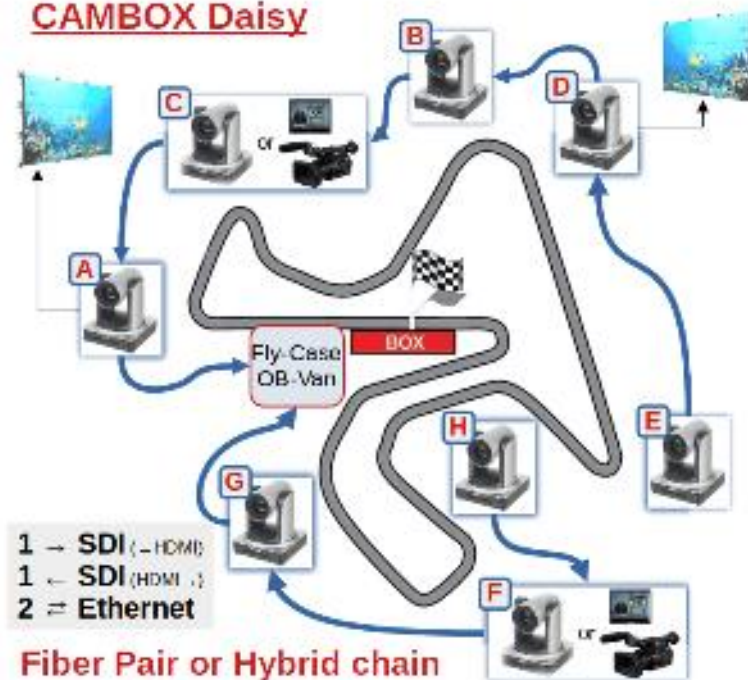

**Daisy or NEXT Application Go-Kart**  
Two cascade (3 + 5) from Flycase



## NEXT Hybrid Loop

*Power supplied to next unit only  
after connection and handshaking  
Main Power can be re-inseted in  
any chain node.*

# VIDEO

- 3G-SDI 1
- 3G-SDI 2
- 3G-SDI 3
- 3G-SDI 4
- 3G-SDI 5
- 3G-SDI 6
- 3G-SDI 7
- 3G-SDI 8

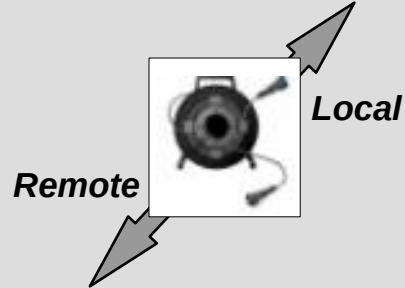

# FlexyBUS

- FlexyBUS 1
- FlexyBUS 2
- FlexyBUS 3
- FlexyBUS 4



Quad Fiber

Positionable on Front



**Power Connector:**  
VDE or Powercon

**Fibers Connector:**  
Neutrik Quad or 4xLC

*Fiber connectors may be positioned on front or rear*



**LinkBox MB**

Utility Quad Fibers Link

**General Purpose Fiber Link**

*Default FlexyBUS: 1G Ethernet*

*Useful to joint two far systems or remote flycase*

*Using FlexyBUS SDI is it possible to carry a total of 8 BiDi Video signals over a Neutrik Quad cable*



# SPU48

## Sony HXC-FB80 Advanced Power Unit

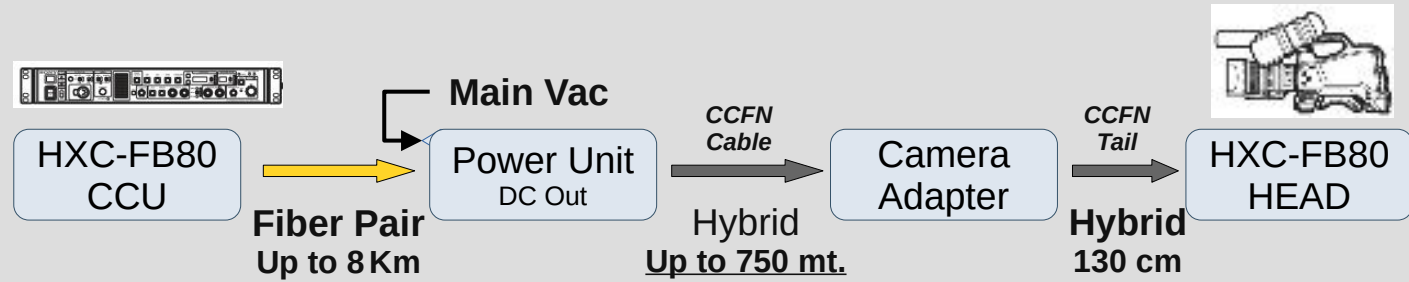

# SPU12

## Multi-Brand Hybrid Cable Power Re-Insertter

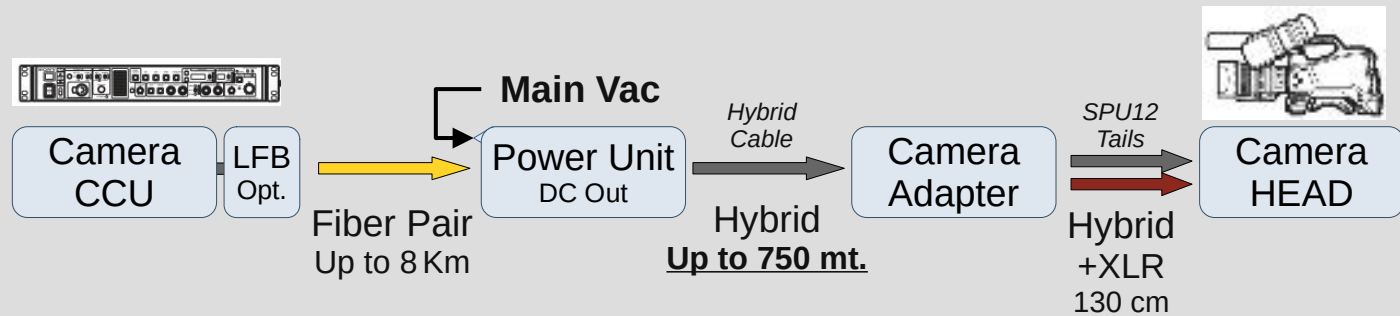

## Hybrid (SMPTE) Power Units SPU

Compatible with GV & Sony cameras  
and Blackmagic URSA converter

## VIDEO - DATA

URSA Video

URSA Video

## AUX

Tally / GPI

## POWER

DC (to Battery Plate)

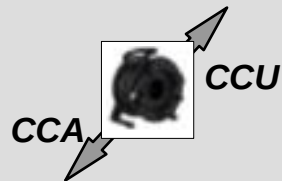

## Blackmagic URSA dedicated Camera LINK

Cambox URSA 12G

Cambox URSA-LT 3G

Cambox URSA-ST Indoor



Neutrik DUO

or

Lemo (SMPTE)

Up to 4 Channels  
in 1RU Controller  
Additional GPI/Tally  
3G Upgradable or 12G

V-Lock or G-Mount Adapters  
Standard or RearFlex Case



The simplest and efficient  
HYBRID LINK for your  
URSA Cameras

## Cambox URSA

**No screws!**

Easily unlock to  
free your camera

Just Snap In







Stadio Meazza - Milano  
Champions League 2021  
Inter - Shakhtar Donetsk



0:05 Two SCALA PTZ Hybrid Interface and/or AW-UE150 captured in live



### Il buco

( Il buco )

All connections for filming with Sony VENICE and communications in the cave were made through devices made ad hoc by REM with connections via optical fiber in very high quality and in real-time



All products are ideated, developer and produced in Italy



Unforgettable RIO 2016 Olympics



*.. to be continued  
new devices coming*

**REM** made in Italy



Coppa Davis Torino 2021